

BRIK HAUS

AGE
12+

BUILD, DESIGN, DISPLAY

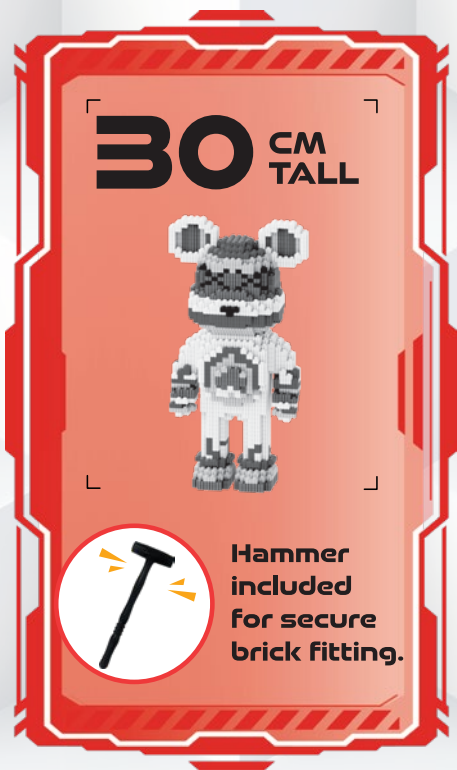

RAINBLOK

BRIK HAUS

BUILD SMART TIPS

1

WHEN YOU OPEN YOUR SET, DON'T DUMP ALL THE ZIGLOCK BRICKS INTO A BIG PILE.

KEEP EACH SET OF BRICKS IN ITS OWN GROUP. SORT THEM BY SIZE, SINGLE, DOUBLE AND TRIPLE AND THEN BY COLOURS.

IT'LL MAKE BUILDING WAY EASIER AND MORE FUN!

2

HOW TO PUT TOGETHER THE ZIGLOCK BRICKS:

LINE UP THE GROOVES AND SLIDE AND STACK TOGETHER.

SLIDE

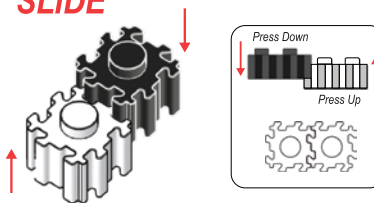

STACK

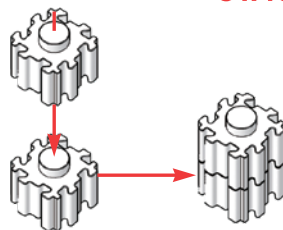

3

THE BLUE PART SHOWS WHAT YOU FINISHED IN THE STEP BEFORE.

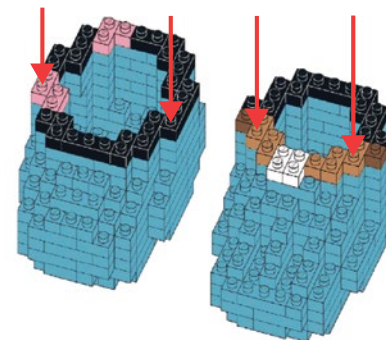

4

ARROWS SHOW WHICH BRICK CONNECTS TO THE NEXT LAYER OF BRICKS.

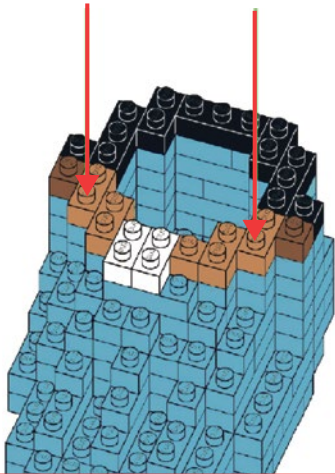

5

USE THE HAMMER TO GENTLY TAP THE PIECES SO THE LAYERS STICK TOGETHER TIGHTLY.

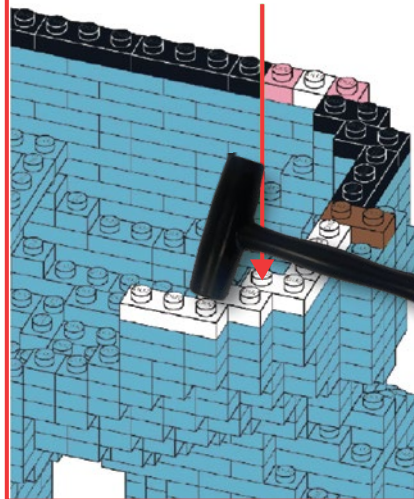

6

DON'T GIVE UP! ZIGLOCK BUILDS TAKE A LITTLE GETTING USED TO, BUT ONCE YOU ARE LOCKED IN, AND A FEW LAYERS LATER, YOU'LL BE BUILDING LIKE A PRO.

SCAN THE QR CODE FOR SOME VISUAL TIPS.



SCAN ME

ADULT ASSISTANCE IS RECOMMENDED. PRODUCT MAY VARY SLIGHTLY FROM IMAGE SHOWN.

1

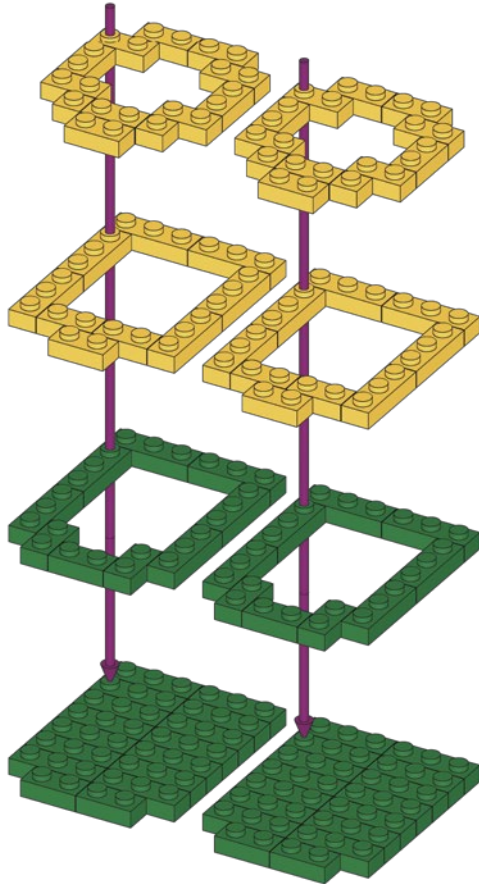
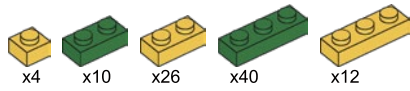

2

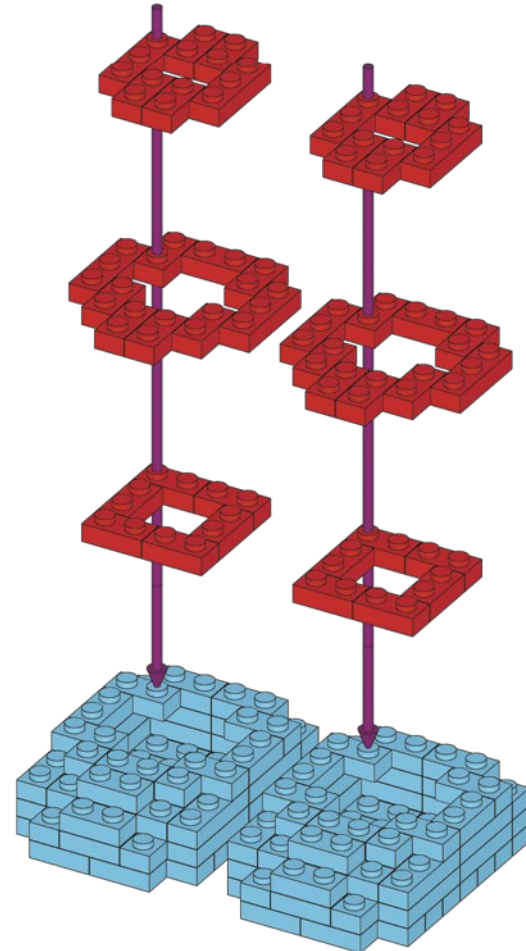
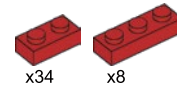

4

3

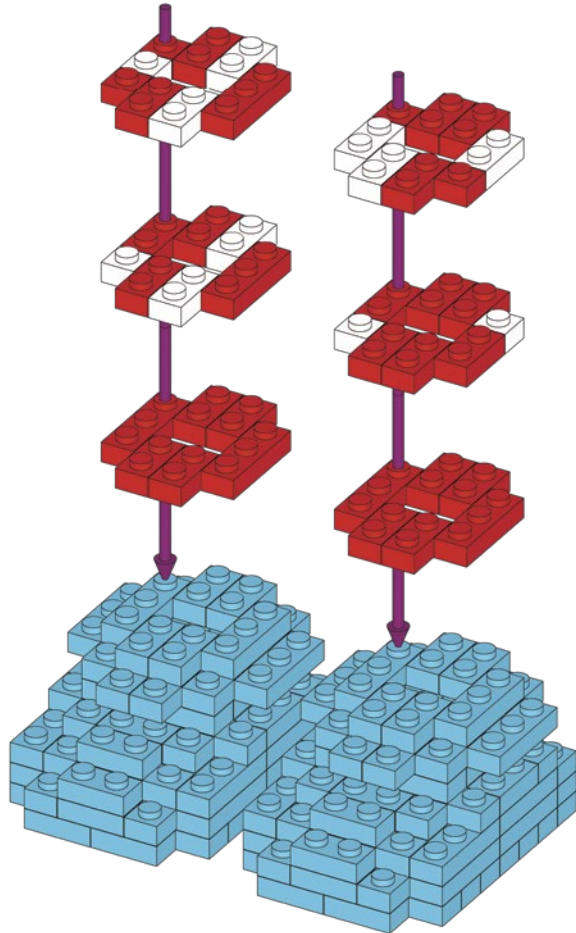
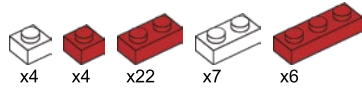

4

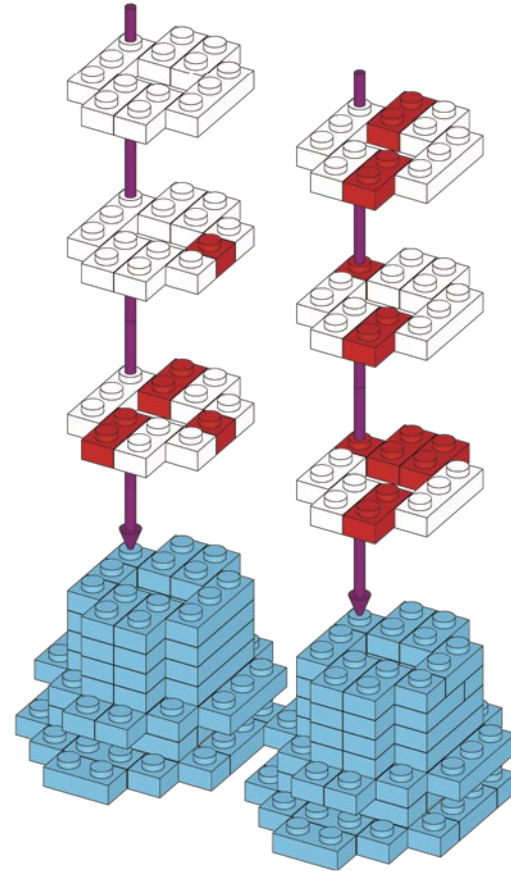
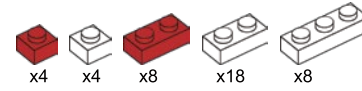

5

5

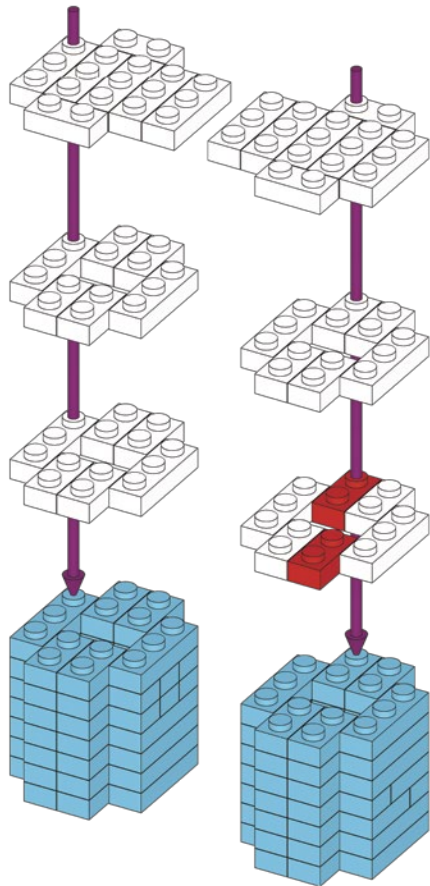
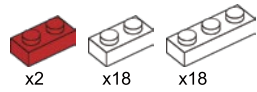

6

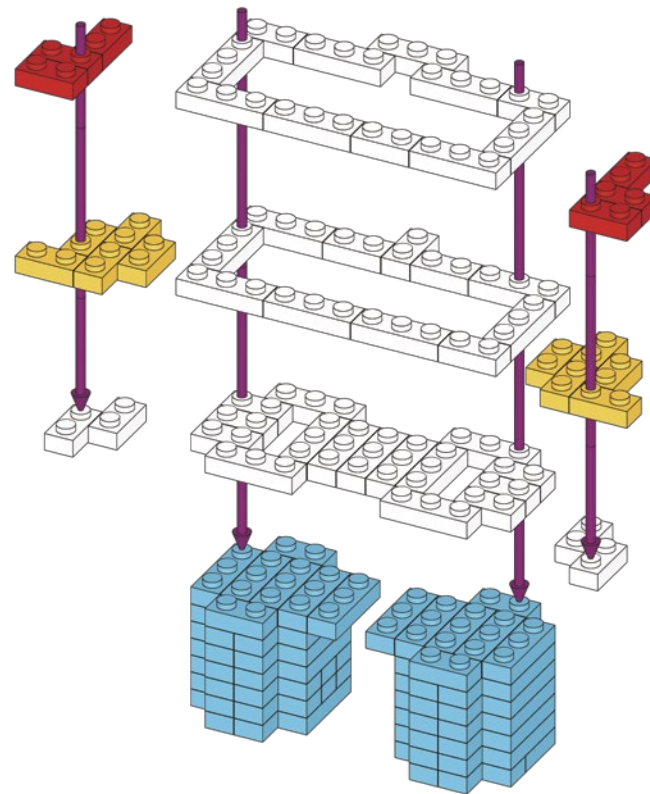
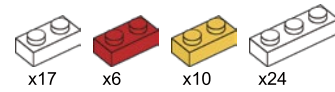

6

7

- x1 (yellow 1x2)
- x4 (white 1x2)
- x38 (white 1x4)
- x4 (yellow 1x4)
- x4 (green 1x4)
- x2 (yellow 1x6)
- x17 (white 1x6)
- x6 (green 1x6)

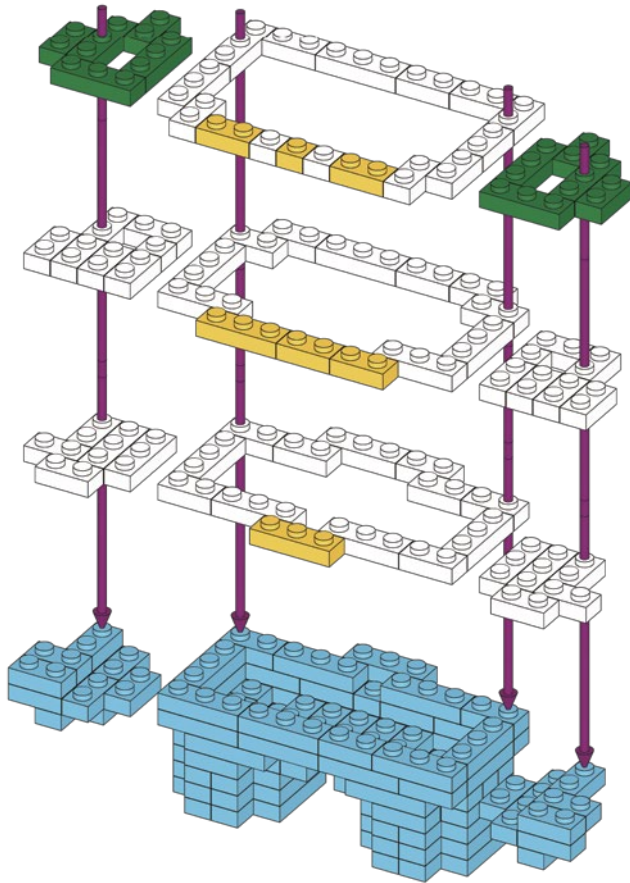





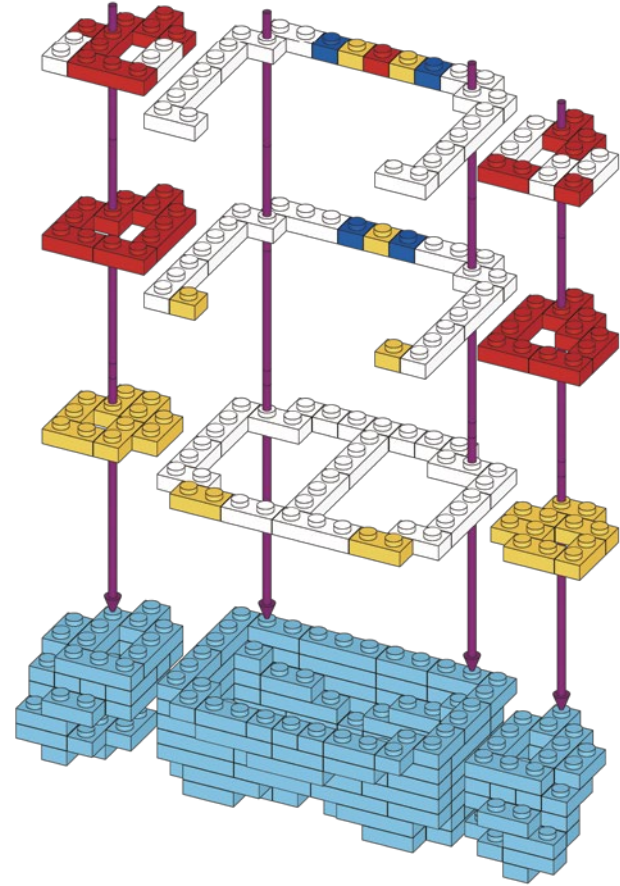



8

- x7 (white 1x2)
- x5 (yellow 1x2)
- x4 (blue 1x2)
- x4 (red 1x2)
- x21 (white 1x4)
- x14 (red 1x4)
- x14 (yellow 1x4)
- x14 (white 1x6)
- x4 (red 1x6)









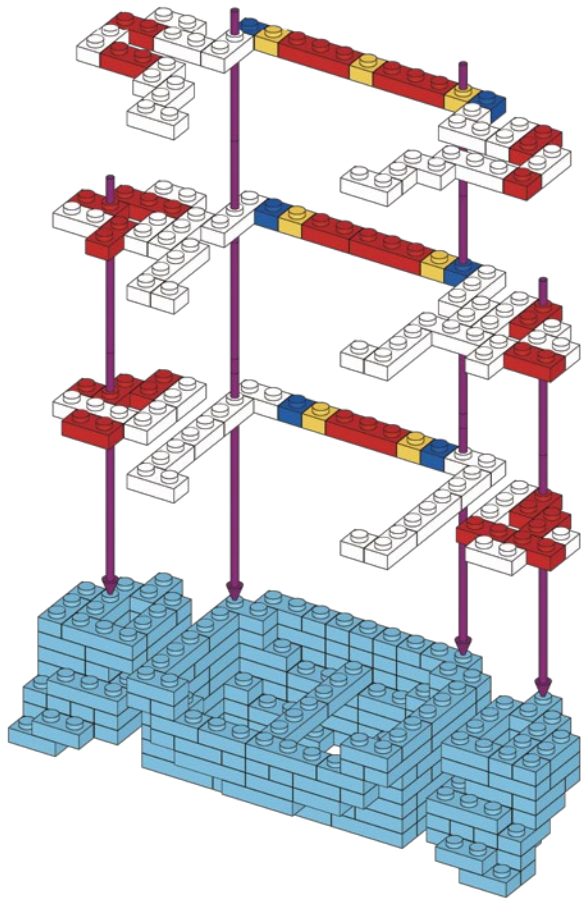



7

9

-  x8
-  x6
-  x2
-  x7
-  x15
-  x29
-  x5
-  x11



10

-  x8
-  x2
-  x4
-  x3
-  x7
-  x2
-  x3
-  x39
-  x2
-  x7

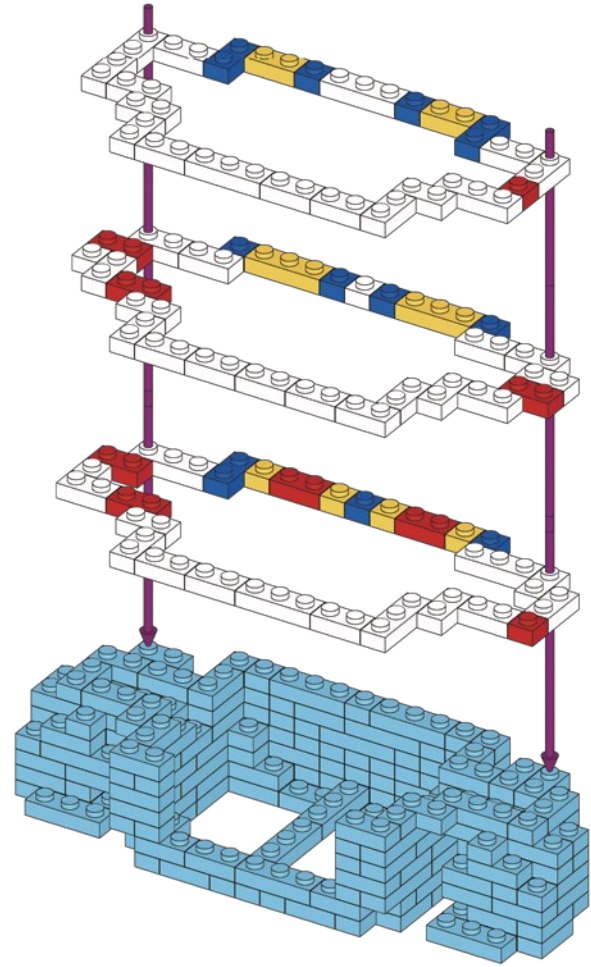

11

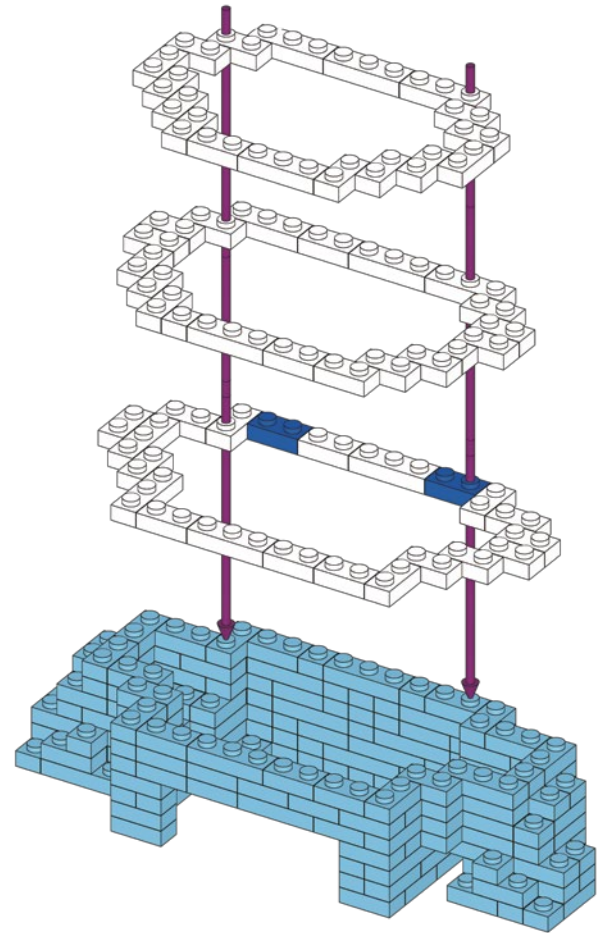
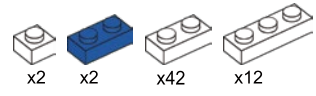

12

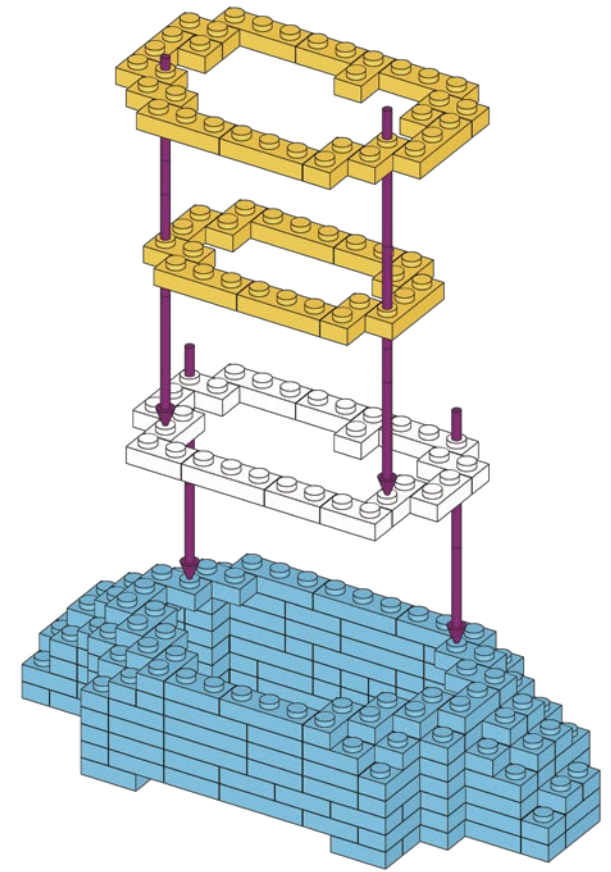
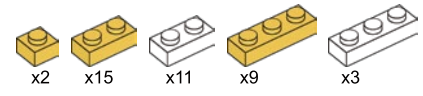

13

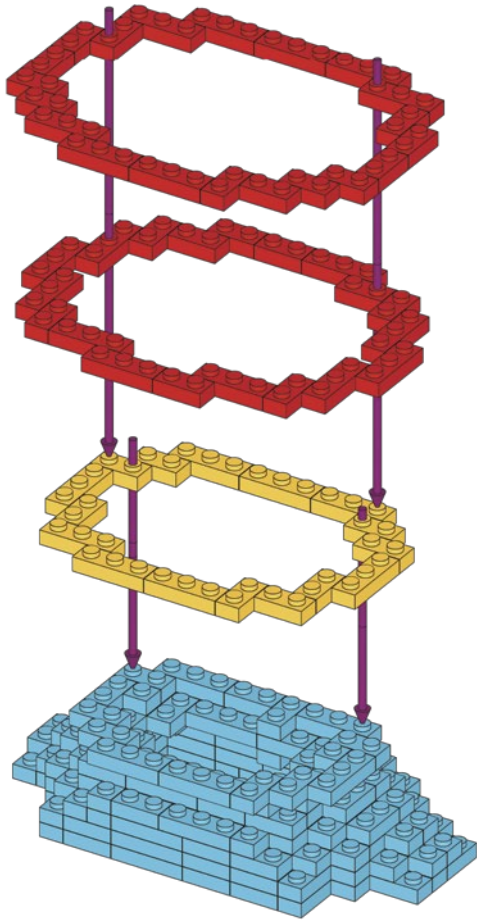
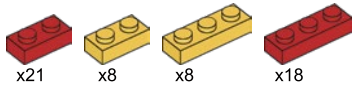

14

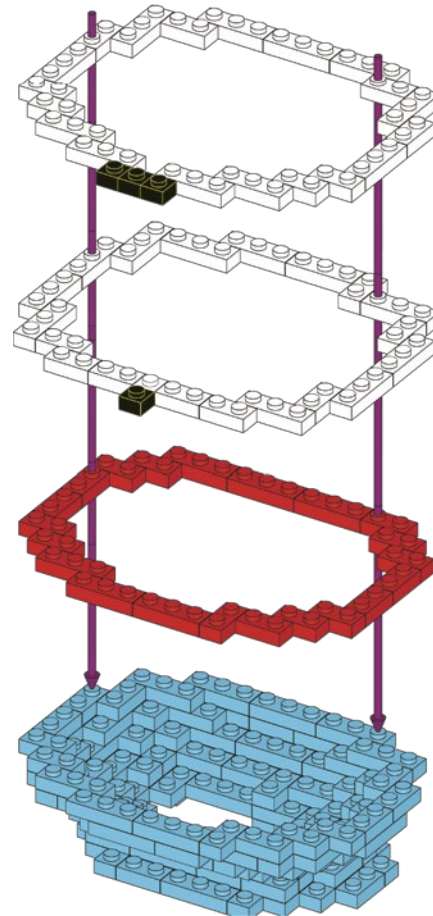
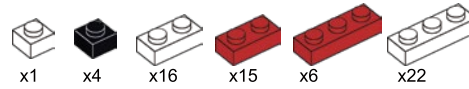

10

15

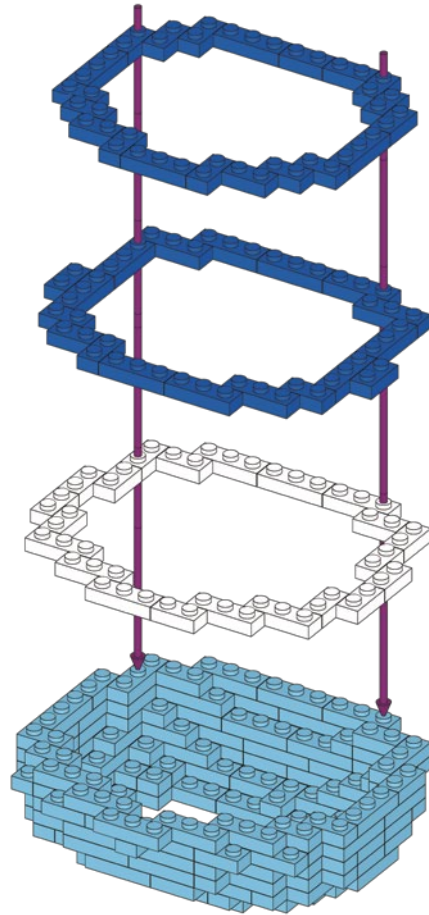
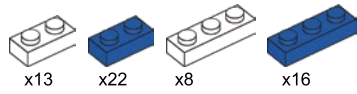

16

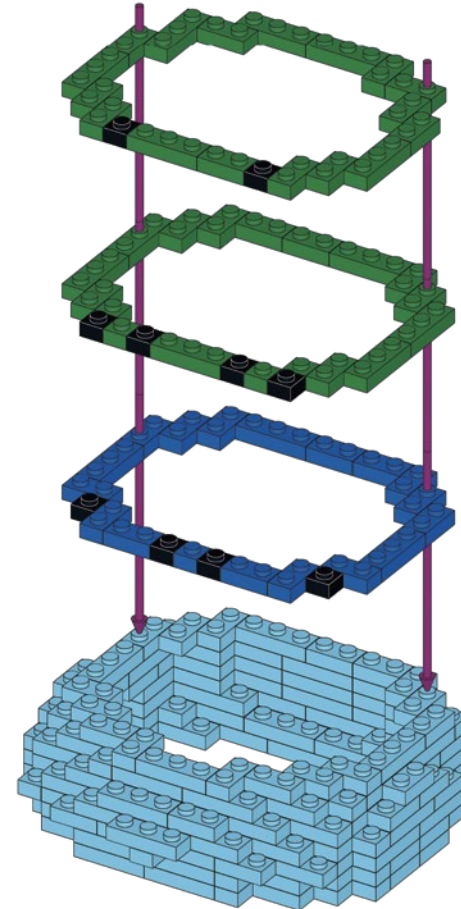
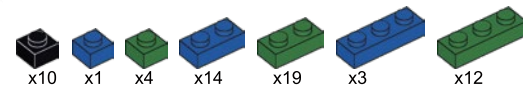

17

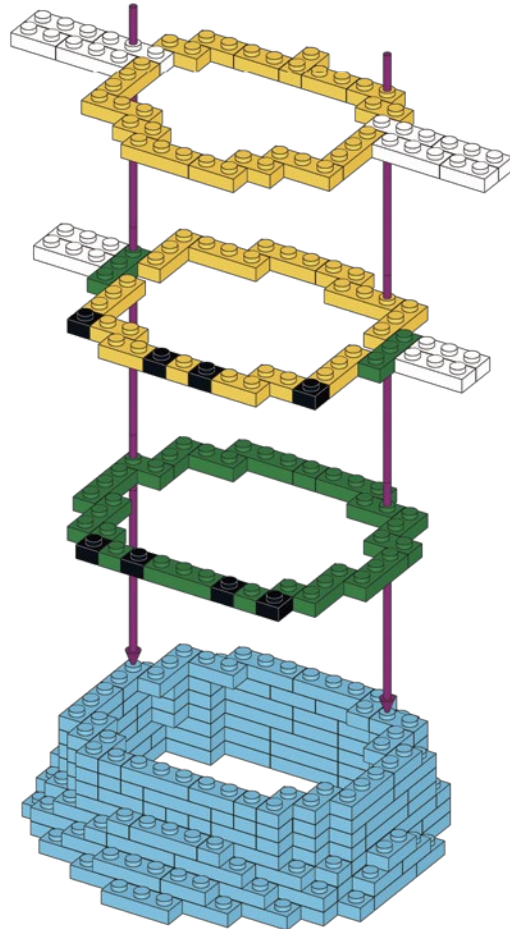
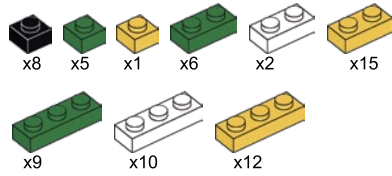

18

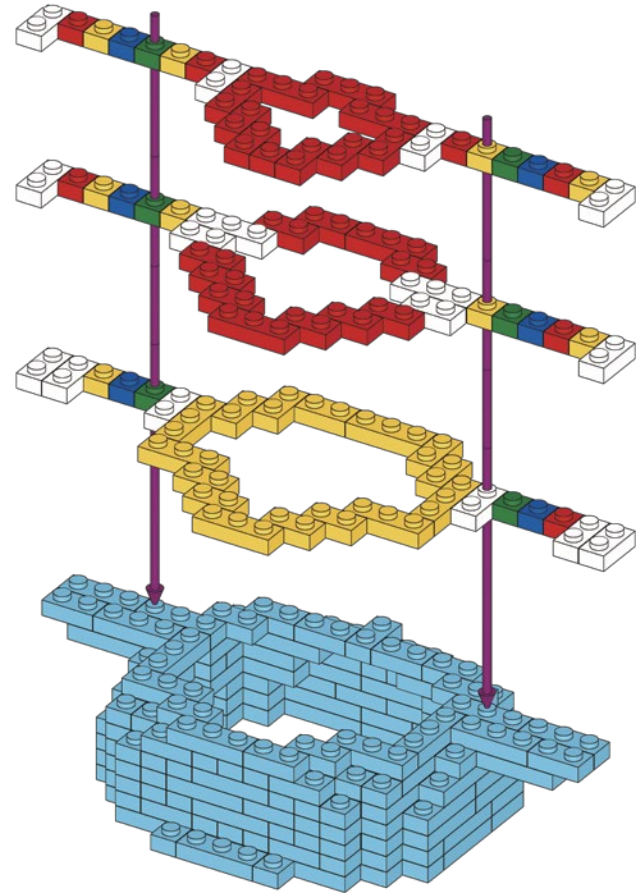
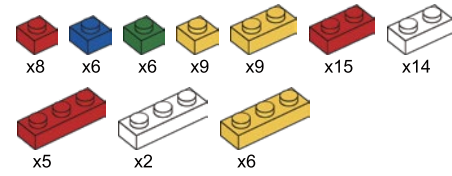

19

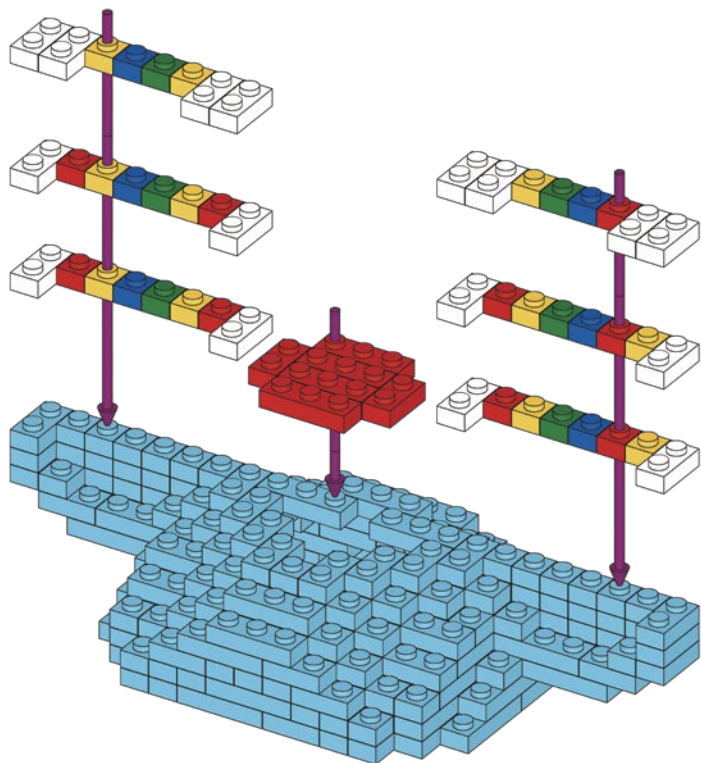
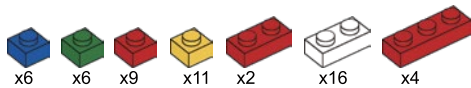

20

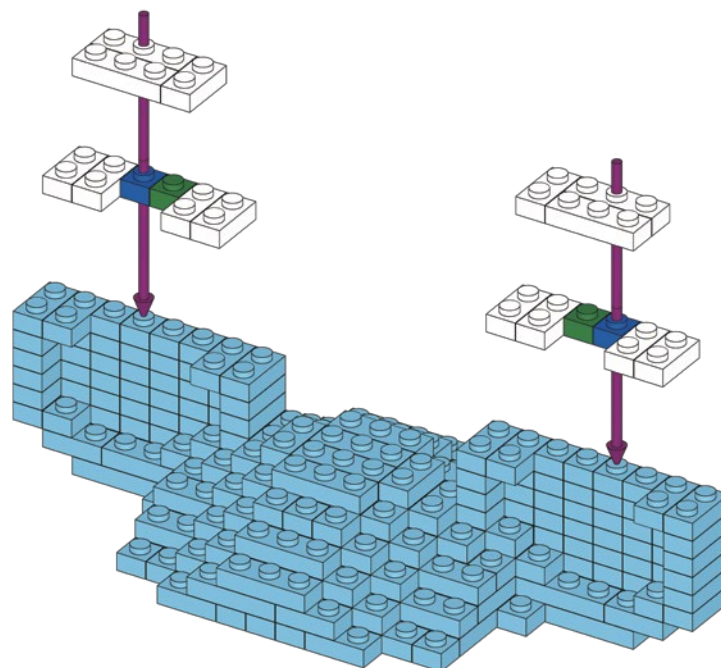
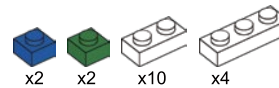

21

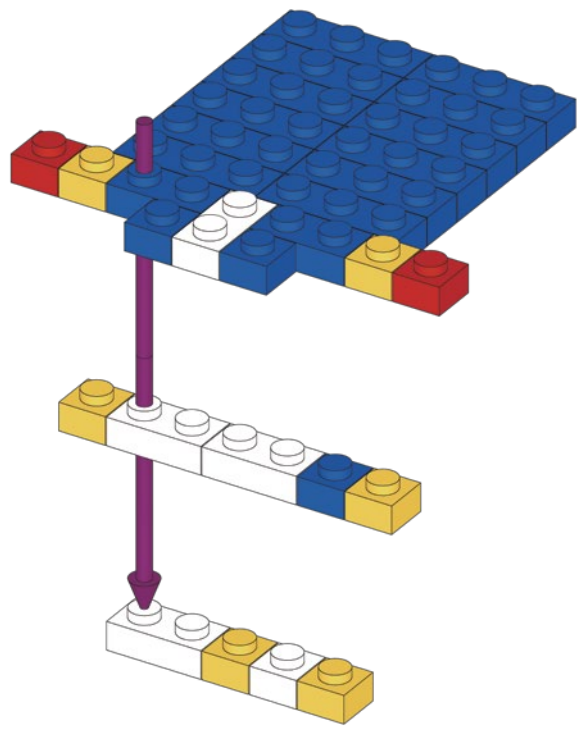
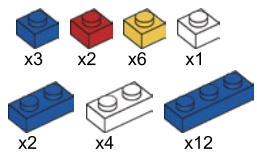

22

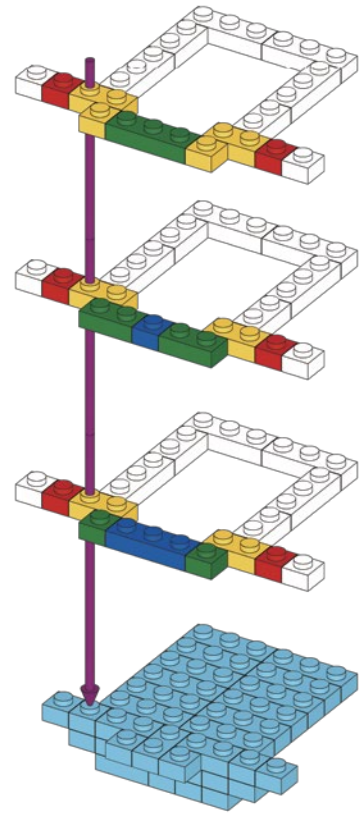
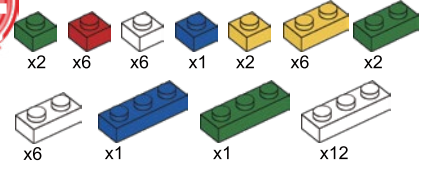

23

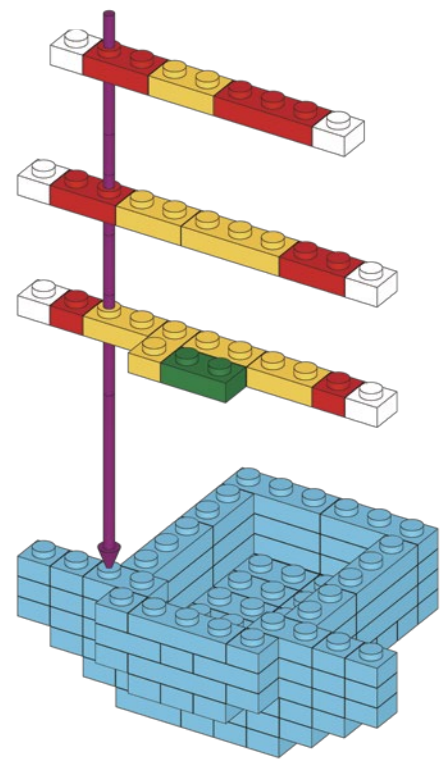
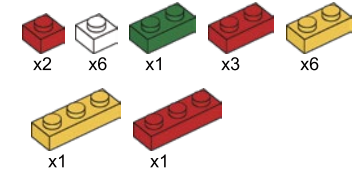

24

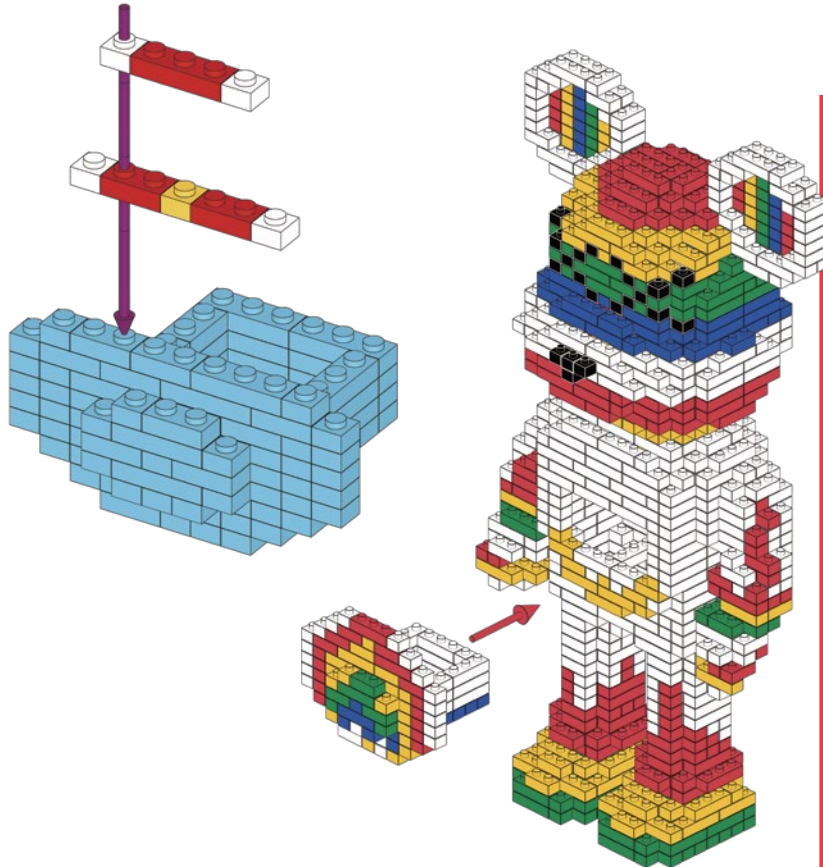
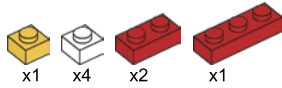

YOU DID IT!

**Your model
is now
complete.
Display
and Enjoy!**



15

RAINBLOK

BRIK HAUS



BUILD, DESIGN, DISPLAY

 **WARNING: CHOKING HAZARD**

SMALL PARTS. NOT SUITABLE FOR CHILDREN UNDER 3 YEARS.

WARNING: FOR SAFETY REASONS, REMOVE ALL PACKAGING, TAGS, LABELS AND PLASTIC FASTENERS BEFORE GIVING THIS TOY TO YOUR CHILD



© 2026 Good Idea Global
Suite 1(A)/207-209 Warrigal Road,
Hughesdale, Victoria, 3166
Melbourne, Australia
www.goodideaglobal.com

Adult assistance is recommended.
Product may vary slightly from image shown.
Please keep the packaging for future reference.

GS-FN0.8985